

Format du papier A3

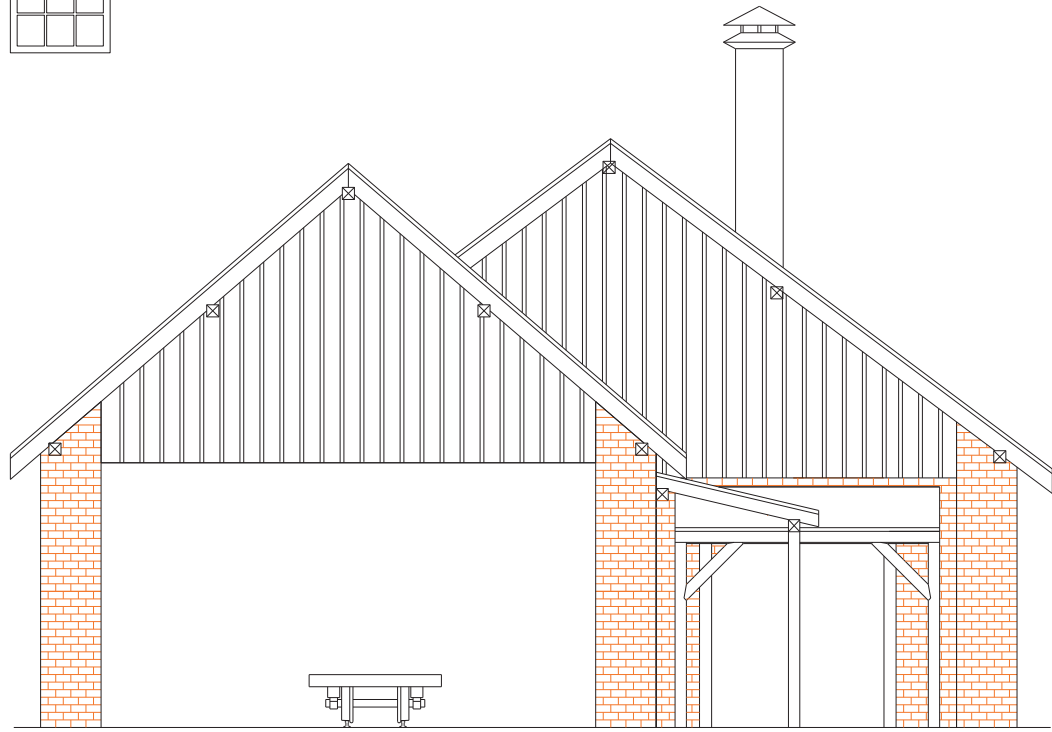

Echelle 1/87

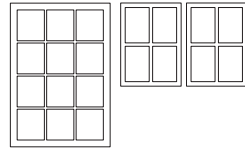
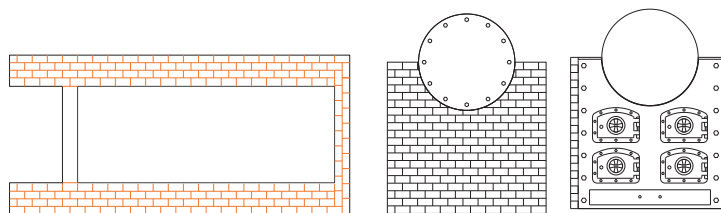
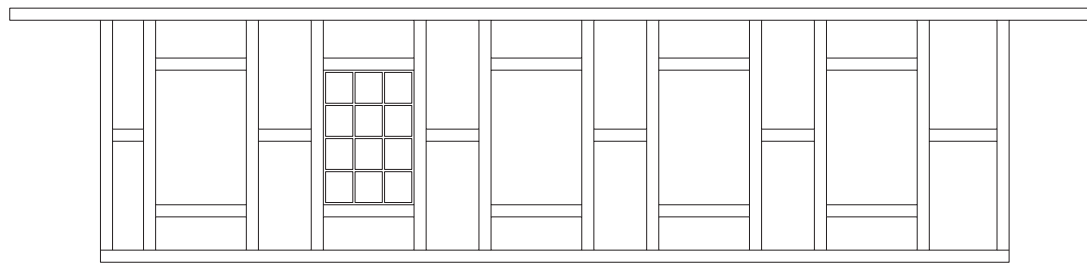
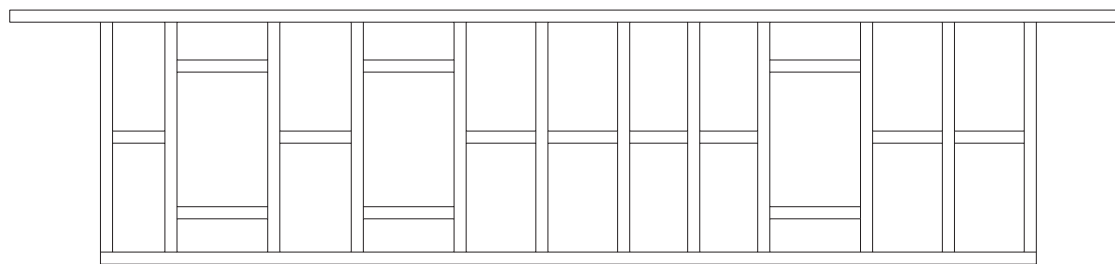
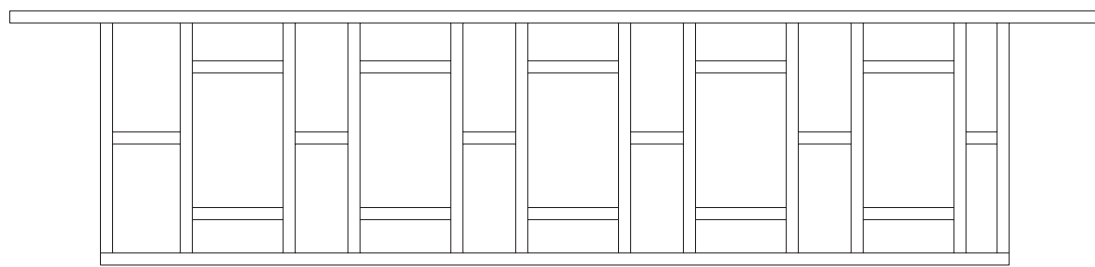
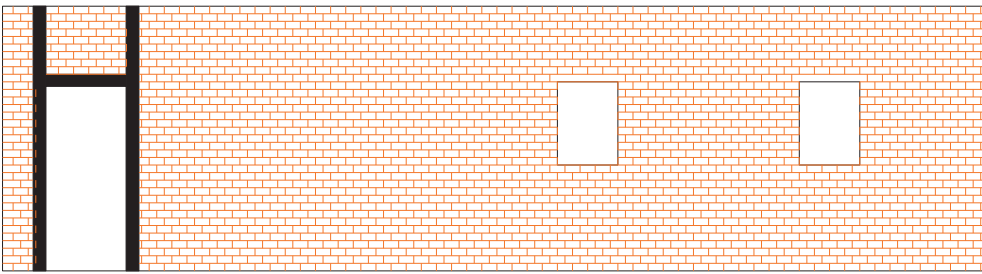
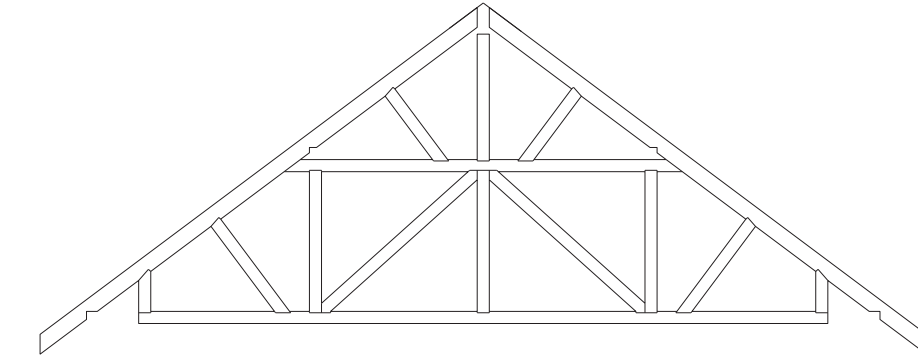
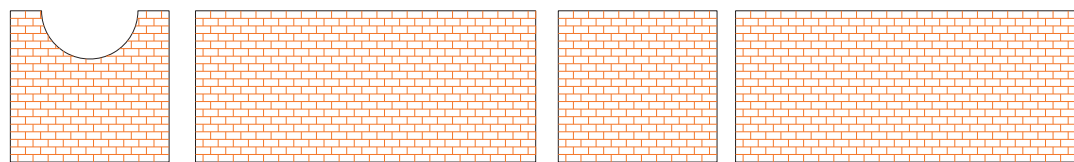
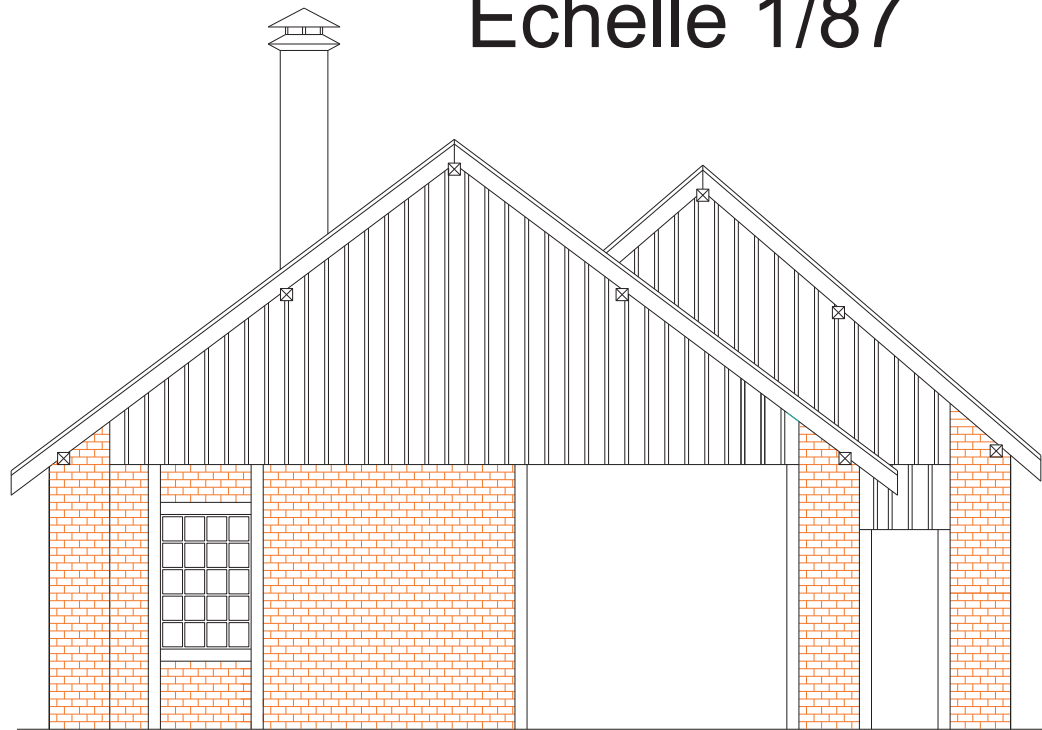

Scierie Werner Gribi 2

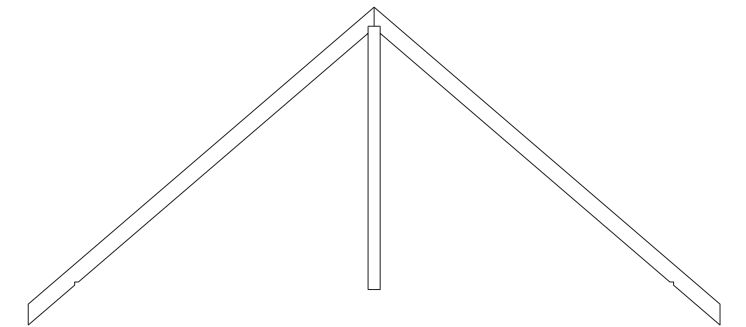
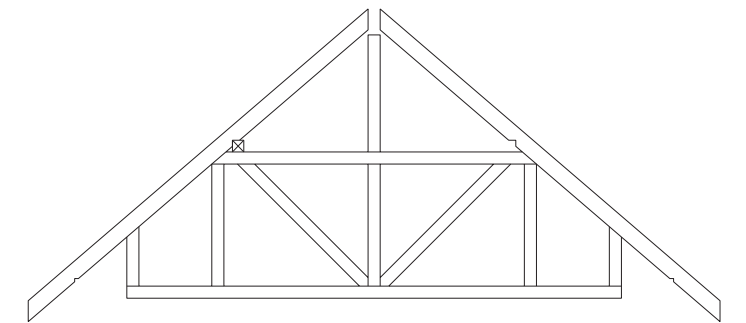
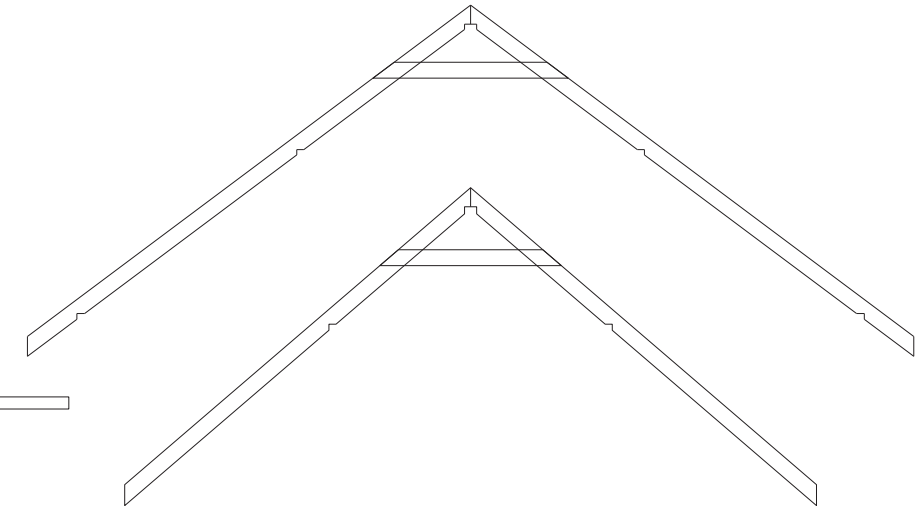
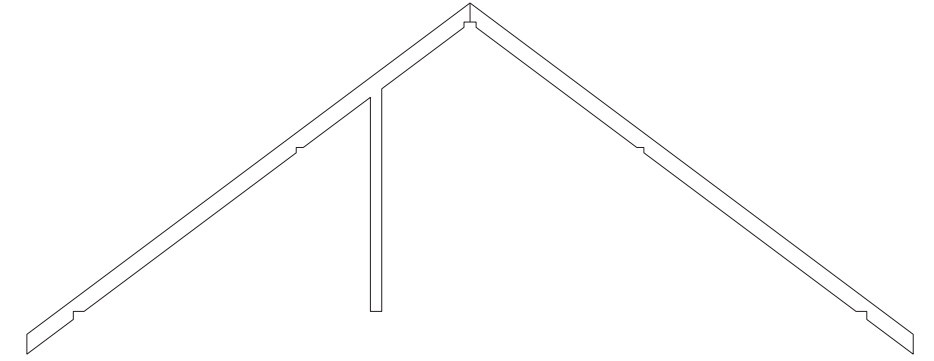

Copyright Gilbert Gribi Novembre 2010

Reproduction interdite sans mon accord écrit

Keine Vervielfältigung erlaubt ohne meine schriftliche Zustimmung

All rights reserved without my written agreement

Echelle 1/87

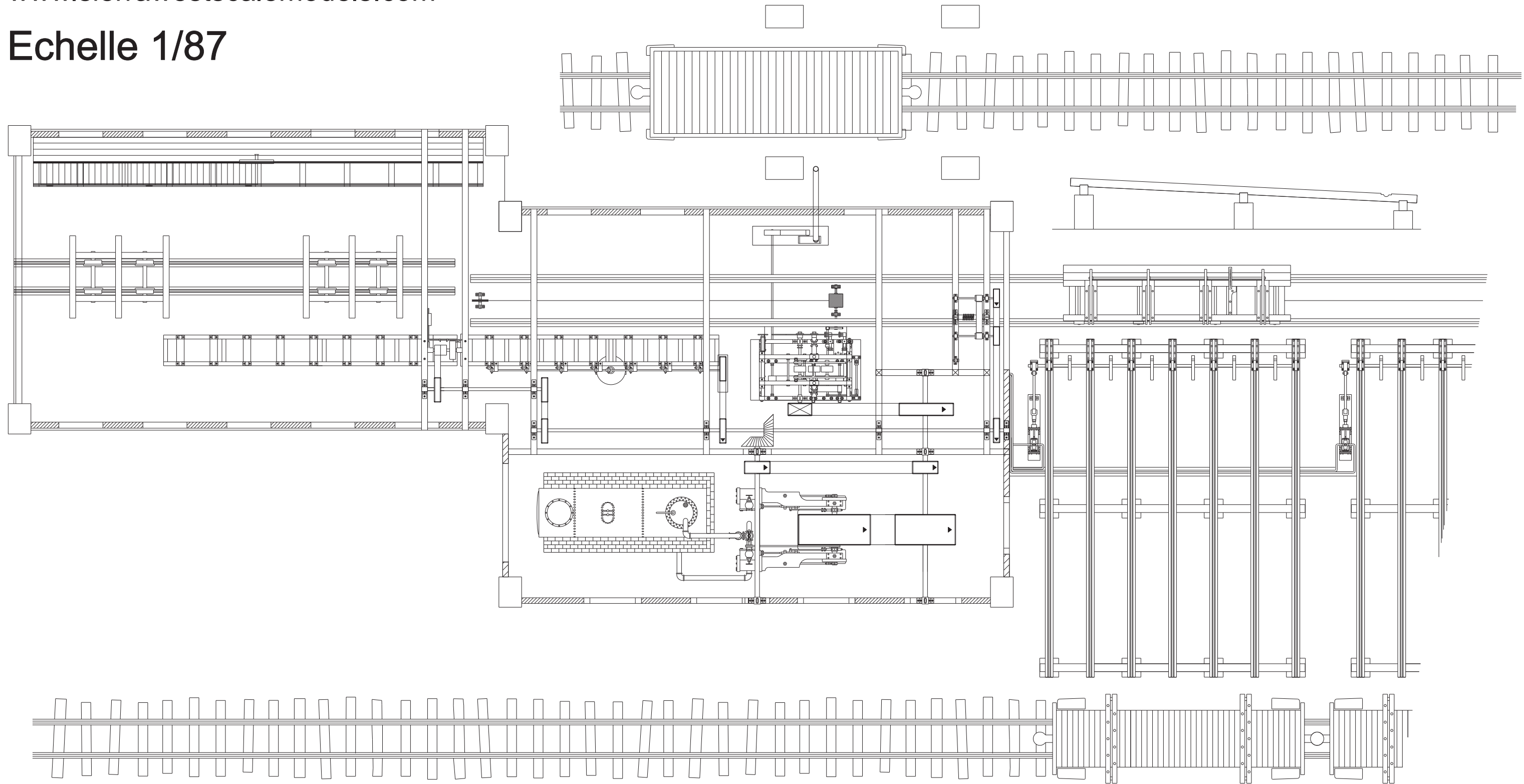

WP-900 Circular Husk

WP-901 Second Blade Option

WP-902 Carriage Hardware

WP-903 Carriage Drive and Sawdust Blower

WP-904 Live Rolls

WP-905 Cut Off Saw and Dead Rolls

WP-907 Log Turner

SB-850 Horizontal Stationary Boiler

Format du papier A3

Copyright Gilbert Gribi Novembre 2010

Reproduction interdite sans mon accord écrit

Keine Vervielfältigung erlaubt ohne meine schriftliche Zustimmung

All rights reserved without my written agreement

Format du papier A3

Scierie Werner Gribi 2

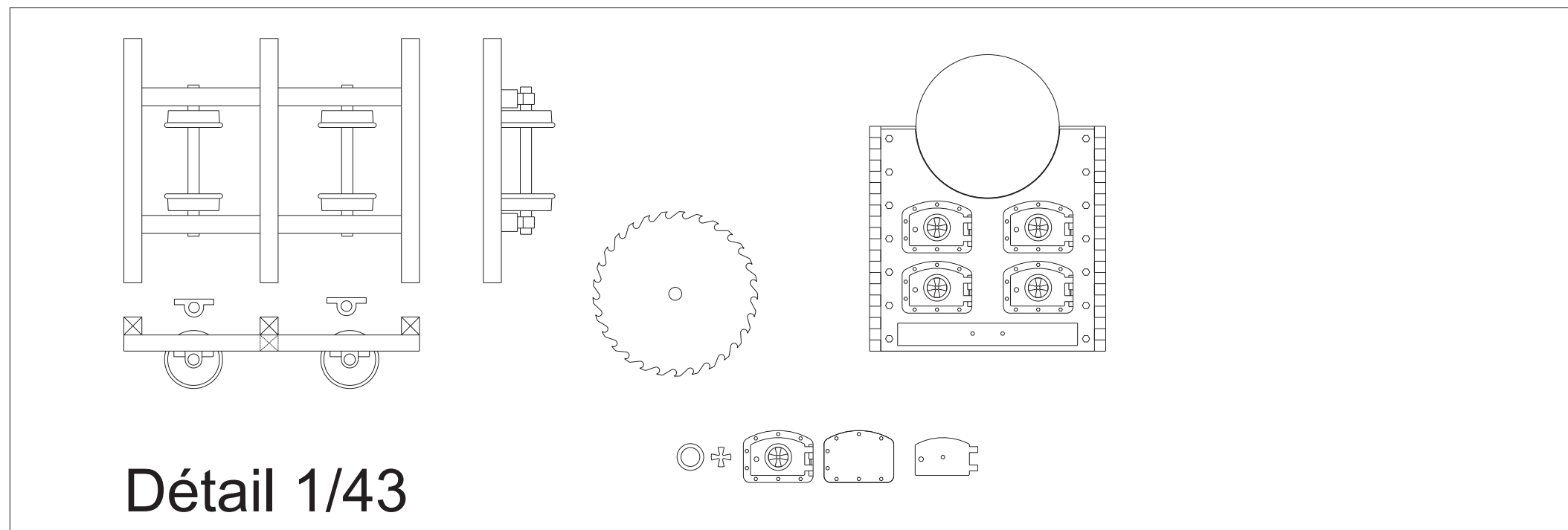
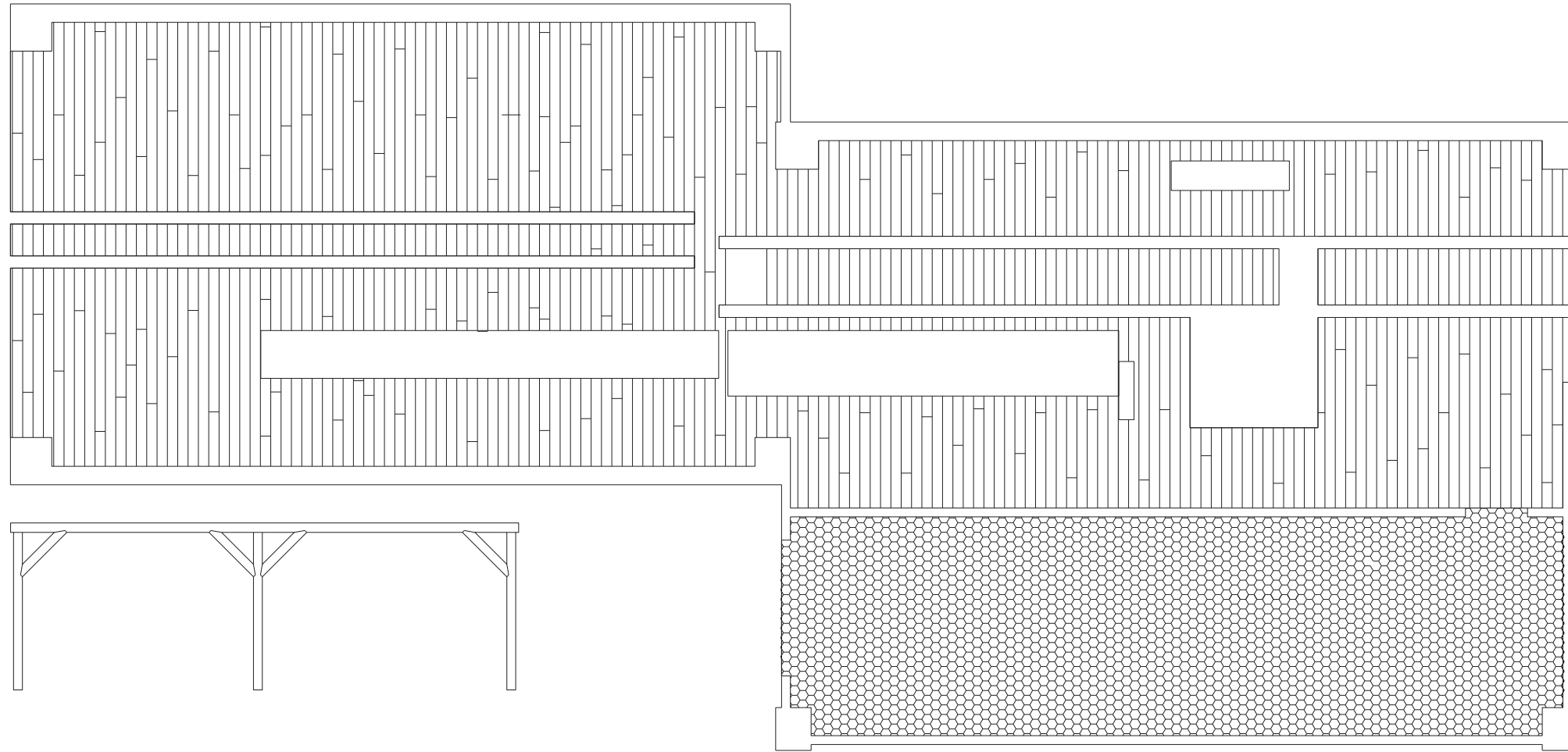

Détail 1/43

Echelle 1/87

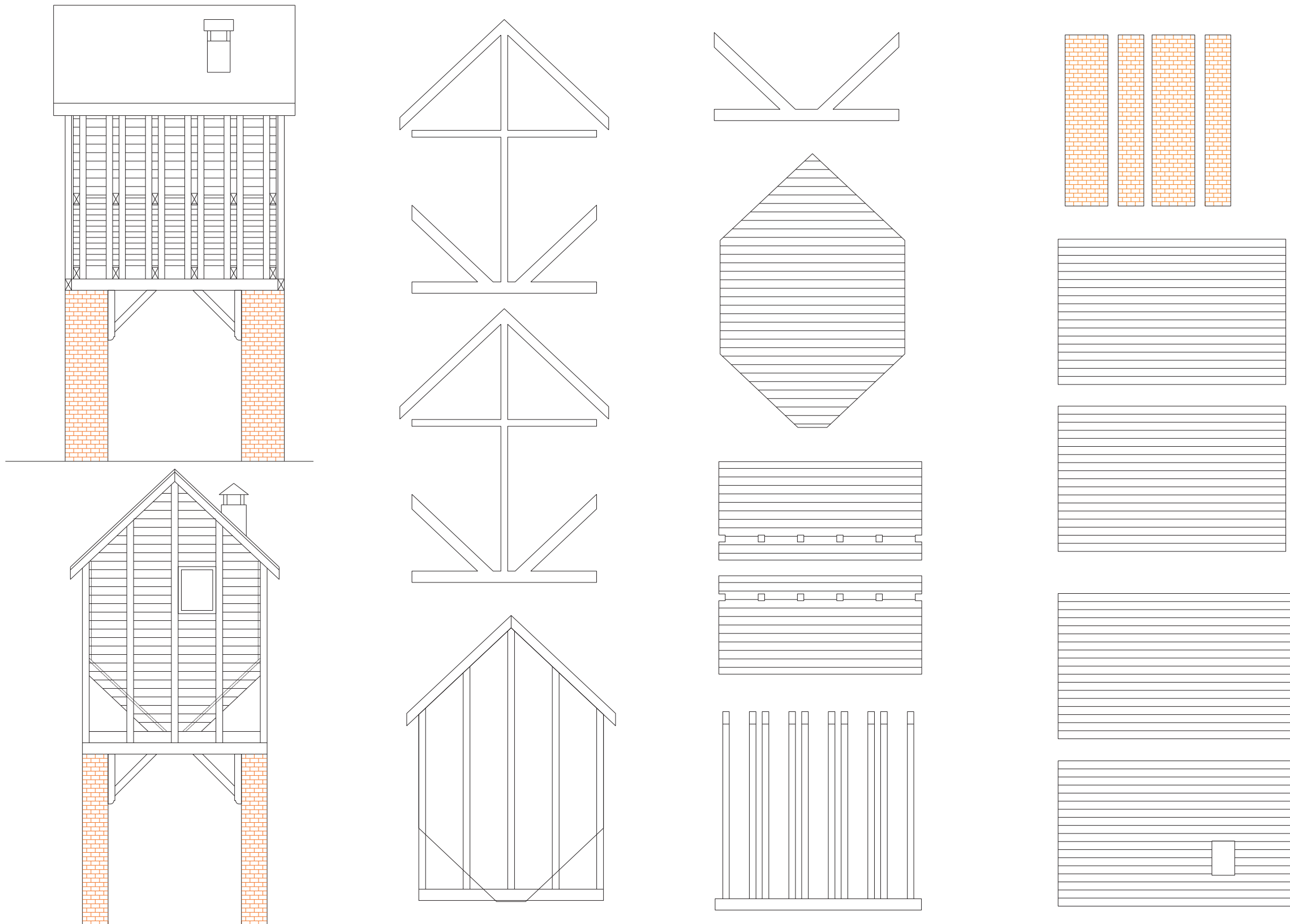

Echelle 1/87